





## Parte esterna termostatico doccia incasso 3 uscite NUOVA EGO\_NE018200



MODELLO **NE018200**

Parte esterna termostatico incasso 3 uscite, con deviasstop 3 uscite, senza parte incasso, per art. ZB018201

### FINITURE DISPONIBILI

-  **21** 21 Cromo
-  **2F** 2F Nichel Spazzolato
-  **40** 40 Nero Opaco
-  **4Q** 4Q Bianco Opaco

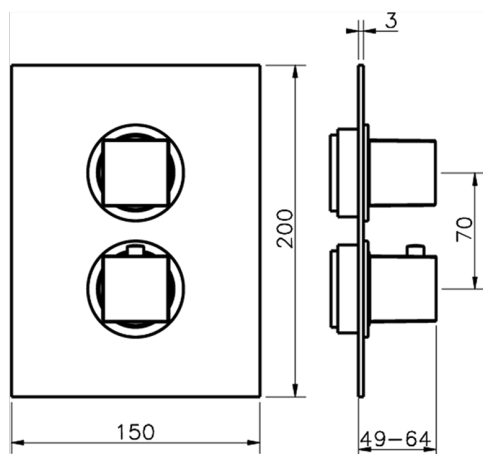

### CARATTERISTICHE

Installazione **Incasso**  
 Parti Incasso necessarie **ZB018201**



### Termostatico

Il Termostatico Huber è il tuo personale gestore dell'acqua che ti aiuta a gestire e controllare acqua ed energia senza sprechi.



## Parte incasso termostatico doccia 3 uscite INCASSO\_ZB018201

MODELLO **ZB018201**

Parte incasso termostatico 3 uscite, con devia stop 3 uscite, senza parte esterna

FINITURE DISPONIBILI



**04** 04 Senza Finitura



CARATTERISTICHE

Installazione	<b>Incasso</b>
Ricambio Cartuccia	<b>24.04A.PP</b>
	<b>Cartuccia Termostatica Plus P 8X20</b>
Incasso	<b>1</b>



Piastra/Plate/Plaque/Platte/Placa  
 2-3mm: XX 25-40 YY 76-91  
 10 mm: XX 16-31 YY 65-80



### DeviaStop

La tecnologia Devia Stop di Huber consente con un semplice movimento rotativo di gestire la portata dell'acqua e di scegliere la modalità d'erogazione (soffione, doccia a mano).



### Termostatico

Il Termostatico Huber è il tuo personale gestore dell'acqua che ti aiuta a gestire e controllare acqua ed energia senza sprechi.



2026-06-09