

Miscelatore termostatico doccia CLINIC&TECHNICAL_CLT01020

MODELLO **CLT01020**

Miscelatore termostatico doccia, senza completo doccia, attacco per flessibile 1/2" M, con leva clinica

FINITURE DISPONIBILI



CARATTERISTICHE

Ricambio Cartuccia **24.04A.PP**

Cartuccia Termostatica Plus P 8X20

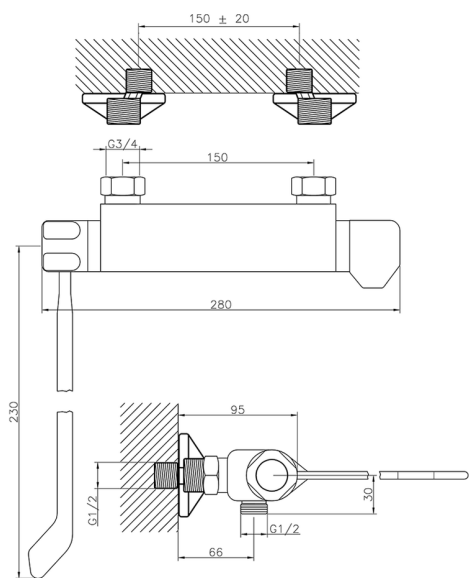

Termostatico

Il Termostatico Huber è il tuo personale gestore dell'acqua che ti aiuta a gestire e controllare acqua ed energia senza sprechi.



2026-06-24