

## Parte esterna monocomando doccia incasso NUOVA KIRUNA\_K2003000

MODELLO **K2003000**

Parte esterna monocomando doccia incasso, senza parte incasso, per art. ZB005300-ZB005301

### FINITURE DISPONIBILI

-  **21** 21 Cromo
-  **26** 26 Vecchio Rame
-  **2F** 2F Nichel Spazzolato
-  **2W** 2W Oro Spazzolato
-  **40** 40 Nero Opaco
-  **4Q** 4Q Bianco Opaco

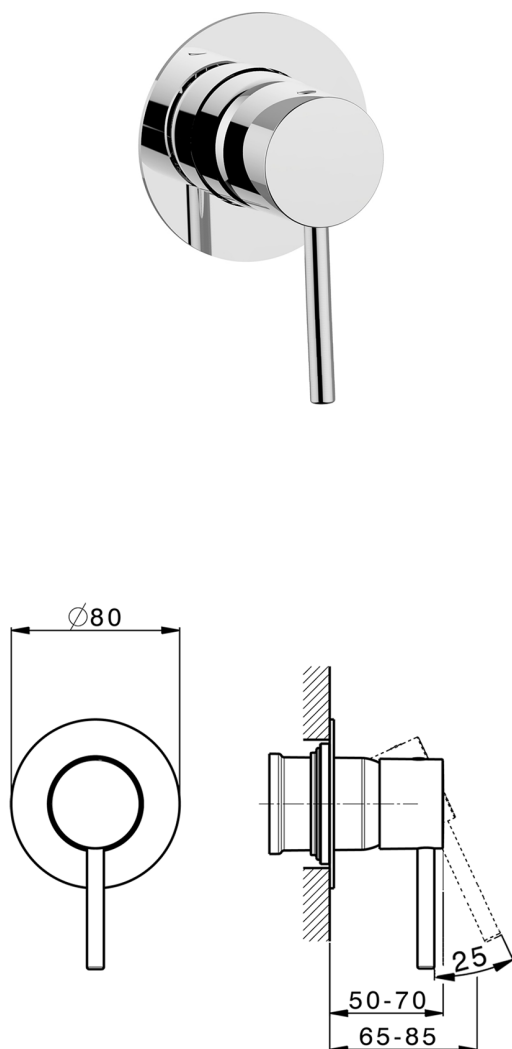

### CARATTERISTICHE

Installazione **Incasso**  
 Parti Incasso necessarie **ZB005301**  
**ZB005300**



## Parte incasso monocomando doccia INCASSO\_ZB005301

MODELLO **ZB005301**

Parte incasso monocomando doccia, doccia incasso 1/2", senza parte esterna, con silenziosi

FINITURE DISPONIBILI



**04** 04 Senza Finitura



CARATTERISTICHE

Installazione	<b>Incasso</b>
Ricambio Cartuccia	<b>ZZ94035000</b>
<b>Cartuccia Monocomando 35 mm</b>	
Incasso	<b>1</b>

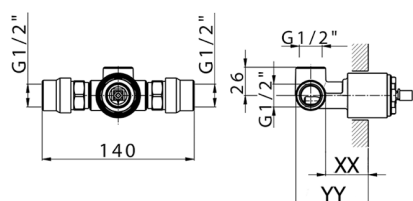

Piastra/Plate/Plaque/Platte/Placa  
 2-3mm: XX 27-47 YY 54-74  
 10mm: XX 16-40 YY 43-68



## Parte incasso monocomando doccia INCASSO\_ZB005300

MODELLO **ZB005300**

Parte incasso monocomando doccia, doccia incasso 1/2", senza parte esterna



FINITURE DISPONIBILI



**04** 04 Senza Finitura

CARATTERISTICHE

Installazione	<b>Incasso</b>
Ricambio Cartuccia	<b>ZZ94035000</b>
<b>Cartuccia Monocomando 35 mm</b>	
Incasso	<b>1</b>



Piastra/Plate/Plaque/Platte/Placa  
 2-3mm: XX 27-47 YY 54-74  
 10mm: XX 16-40 YY 43-68



2026-05-15