

Parte esterna termostatico doccia incasso 1 uscita THERMO_NE007300

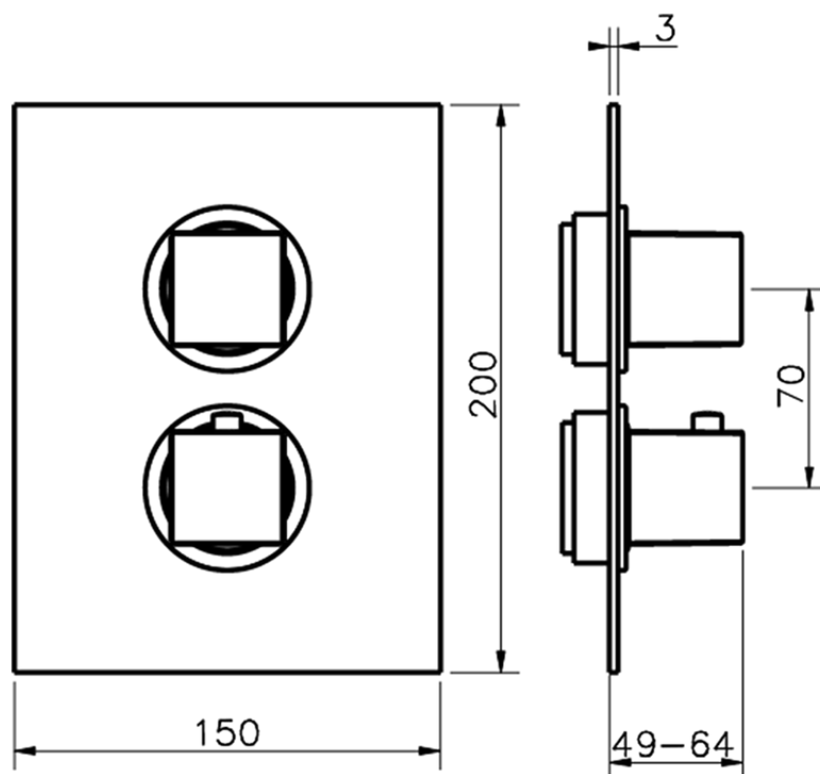

NE007300

<http://www.huberitalia.com/parte-esterna-termostatico-doccia-incasso-1-uscita-thermo-ne007300>



Piastra/Plate/Plaque/Platte/Placa

2-3mm: XX 25-40 YY 76-91

10 mm: XX 16-31 YY 65-80

ZB007301

<http://www.huberitalia.com/parte-incasso-termostatico-doccia-1-uscita-incasso-zb007301>

2026-04-27