

Parte esterna termostatico doccia incasso 3 uscite H2_H2018200

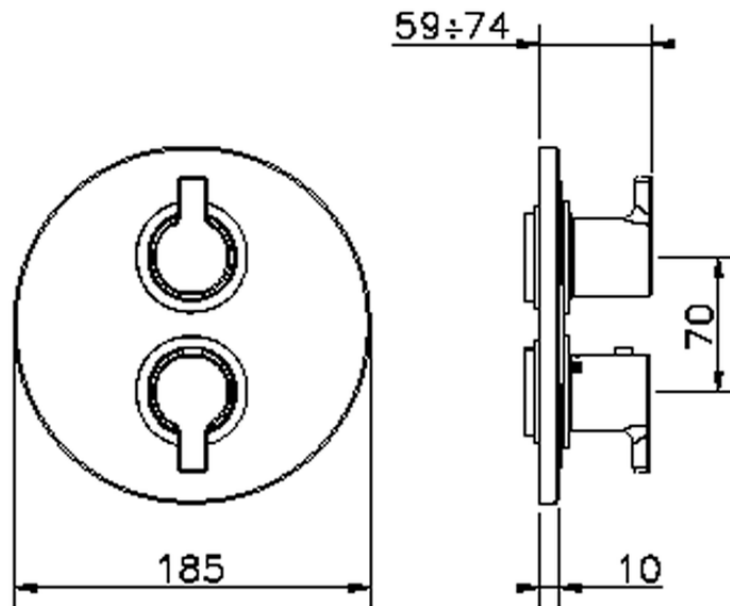

H2018200

<http://www.huberitalia.com/parte-esterna-termostatico-doccia-incasso-3-uscite-h2-h2018200>



Piastra/Plate/Plaque/Platte/Placa

2-3mm: XX 25-40 YY 76-91

10 mm: XX 16-31 YY 65-80

ZB018201

<http://www.huberitalia.com/parte-incasso-termostatico-doccia-3-uscite-incasso-zb018201>

2026-05-14