

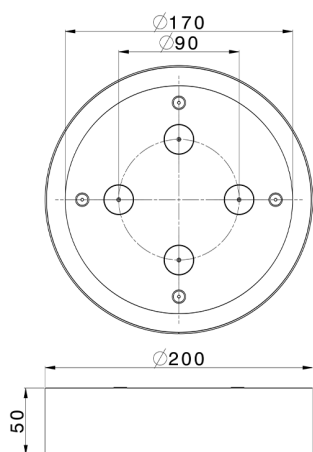

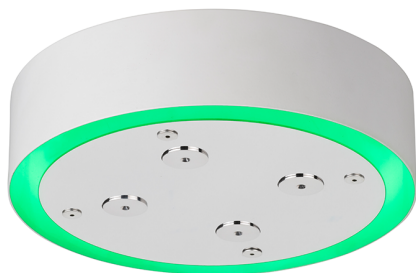

Soffione a soffitto con cromoterapia Ø 200 mm ZEN_ZS1C0270

MODELLO **ZS1C0270**

Soffione a soffitto con cromoterapia Ø 200 mm, con carter esterno bianco, funzioni nebulizzazione, cromoterapia, da abbinare a comando incasso/wireless, acciaio inox AISI 304



FINITURE DISPONIBILI

-  **D1** D1 Inox Spazzolato
-  **40** 40 Nero Opaco
-  **4Q** 4Q Bianco Opaco
-  **D2** D2 Inox Lucido

CARATTERISTICHE



2026-06-29