

Parte esterna termostatico doccia incasso 1 uscita LEVITY_LY007300

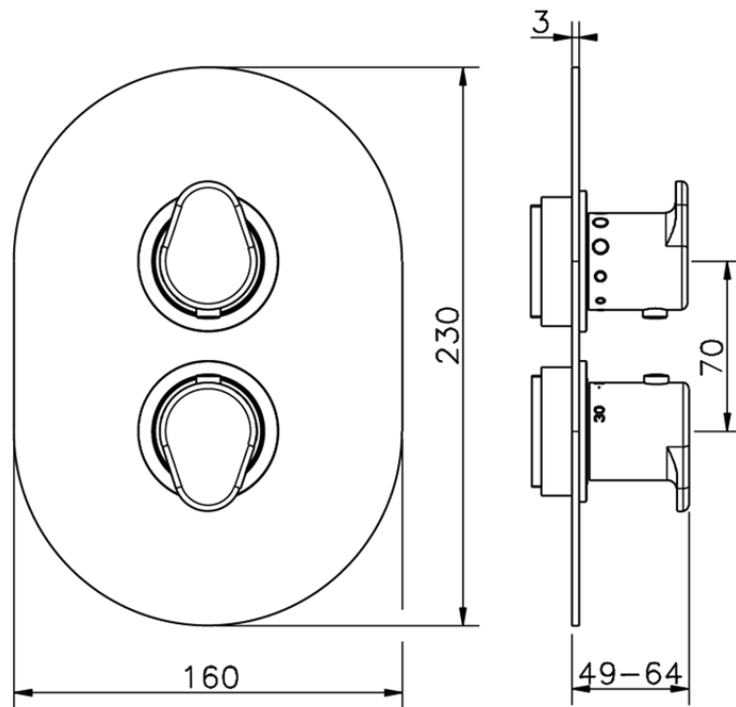

LY007300

<https://www.huberitalia.com/parte-esterna-termostatico-doccia-incasso-1-uscita-levity-ly007300>



Piastra/Plate/Plaque/Platte/Placa

2-3mm: XX 25-40 YY 76-91

10 mm: XX 16-31 YY 65-80

ZB007301

<https://www.huberitalia.com/parte-incasso-termostatico-doccia-1-uscita-incasso-zb007301>

2026-04-17