

Miscelatore monocomando livello EnergySave NUOVA KIRUNA_K2000535

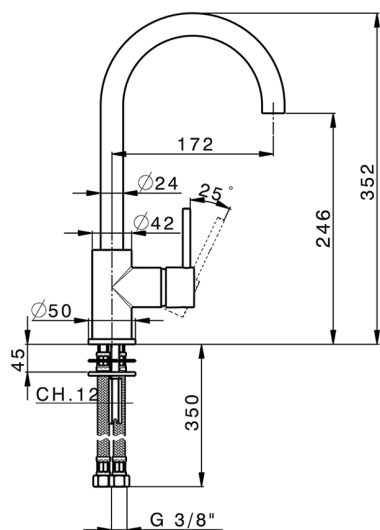

MODELLO **K2000535**

Miscelatore monocomando alto EnergySave, bocca girevole, flex inox G.3/8"

FINITURE DISPONIBILI

-  **21** 21 Cromo
-  **26** 26 Vecchio Rame
-  **2F** 2F Nichel Spazzolato
-  **2W** 2W Oro Spazzolato
-  **40** 40 Nero Opaco
-  **4Q** 4Q Bianco Opaco

CARATTERISTICHE

Ricambio Cartuccia **ZZ95409000**

Cartuccia Monocomando 35 mm



DeviaStop

La tecnologia Devia Stop di Huber consente con un semplice movimento rotativo di gestire la portata dell'acqua e di scegliere la modalità d'erogazione (soffione, doccetta a mano).



EnergySave

Con il dispositivo EnergySave, all'apertura con leva in posizione centrale il miscelatore eroga unicamente acqua fredda, evitando così l'inutile accensione della caldaia e il conseguente spreco di acqua calda, con il beneficio di un notevole risparmio energetico ed economico. La regolazione della temperatura avviene ruotando la leva verso sinistra, fino alla temperatura massima desiderata.



Miscelatore monocomando lavello EnergySave NUOVA KIRUNA_K2000535

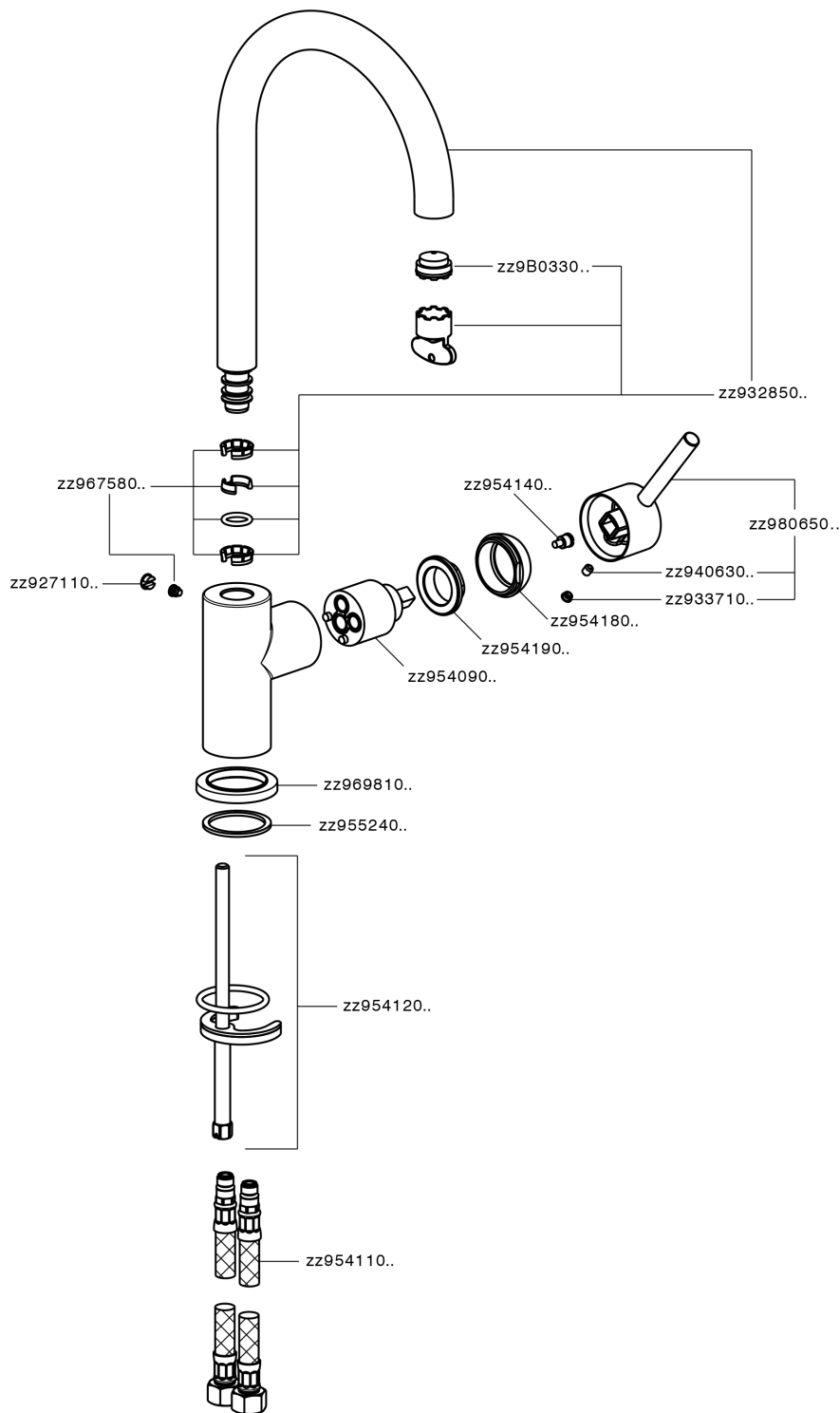

K2000535

<https://www.huberitalia.com/miscelatore-monocomando-lavello-energysave-nuova-kiruna-k2000535>

2026-04-29