







Parte esterna monocomando vasca a pavimento M32_MT014200

MODELLO **MT014200**

Parte esterna monocomando vasca a pavimento, supporto doccetta su colonna, doccetta monogetto D.23 mm in Ottone, flessibile liscio SUPREME 150 cm, senza parte incasso (per art.ZB004510)

FINITURE DISPONIBILI

-  **21** 21 Cromo
-  **26** 26 Vecchio Rame
-  **2F** 2F Nichel Spazzolato
-  **2W** 2W Oro Spazzolato
-  **40** 40 Nero Opaco
-  **4Q** 4Q Bianco Opaco

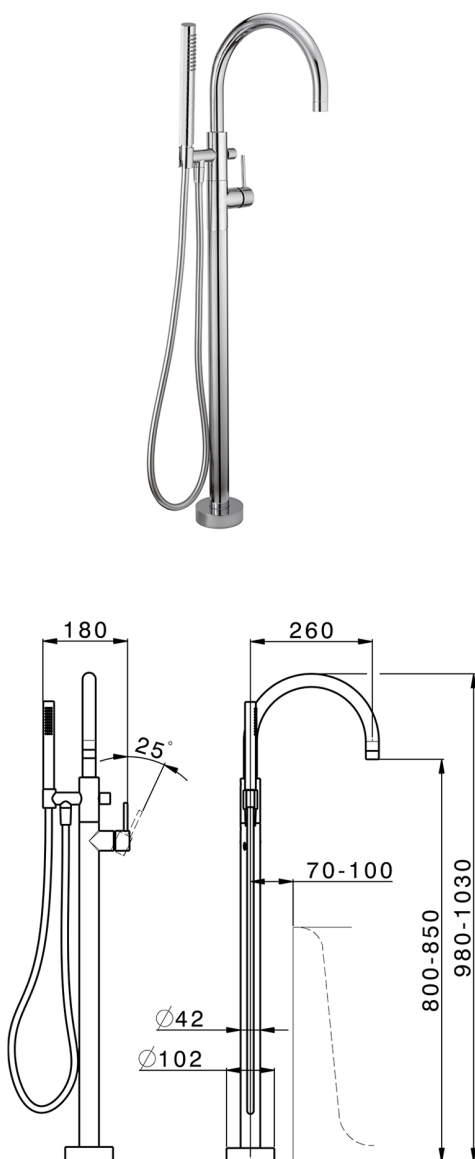

CARATTERISTICHE

Ricambio Cartuccia **ZZ95409000**

Cartuccia Monocomando 35 mm

Installazione **Incasso**

Parti Incasso necessarie **ZB004510**



Parte esterna monocomando vasca a pavimento M32_MT014200

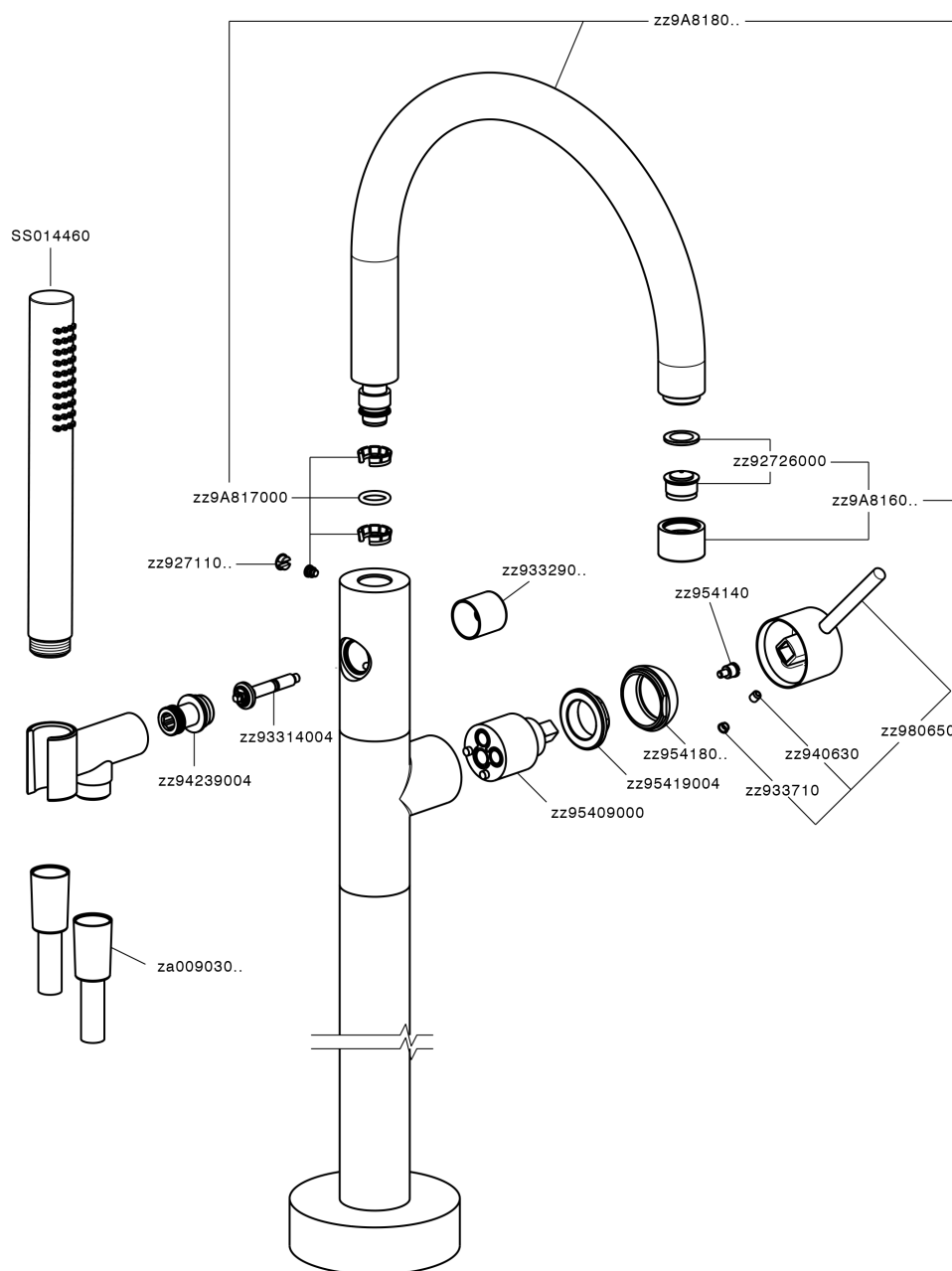

MT014200

<https://www.huberitalia.com/parte-esterna-monocomando-vasca-a-pavimento-m32-mt014200>

Parte incasso monocomando free-standing INCASSO_ZB004510

MODELLO **ZB004510**

Parte incasso a pavimento, per monocomando free-standing

FINITURE DISPONIBILI

 **04** 04 Senza Finitura



CARATTERISTICHE

Installazione	Incasso
Incasso	1



2026-07-01