

Parte esterna monocomando doccia incasso NUOVA KIRUNA_K2003000

MODELLO **K2003000**

Parte esterna monocomando doccia incasso, senza parte incasso, per art. ZB005300-ZB005301

FINITURE DISPONIBILI

-  **21** 21 Cromo
-  **26** 26 Vecchio Rame
-  **2F** 2F Nichel Spazzolato
-  **2W** 2W Oro Spazzolato
-  **40** 40 Nero Opaco
-  **4Q** 4Q Bianco Opaco

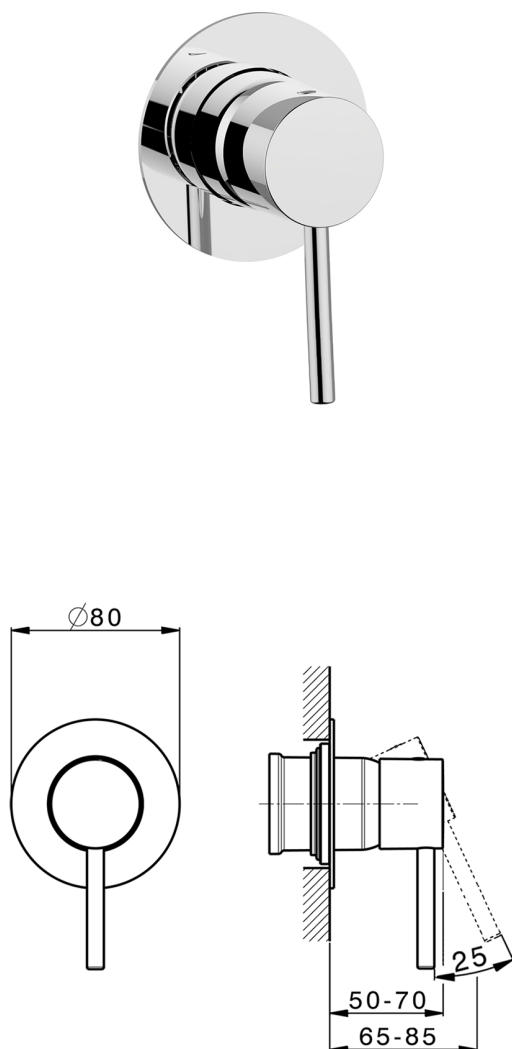

CARATTERISTICHE

Installazione **Incasso**
 Parti Incasso necessarie **ZB005301**
ZB005300



Parte incasso monocomando doccia INCASSO_ZB005301

MODELLO **ZB005301**

Parte incasso monocomando doccia, doccia incasso 1/2", senza parte esterna, con silenziosi

FINITURE DISPONIBILI



04 04 Senza Finitura



CARATTERISTICHE

Installazione	Incasso
Ricambio Cartuccia	ZZ94035000
Cartuccia Monocomando 35 mm	
Incasso	1



Piastra/Plate/Plaque/Platte/Placa
 2-3mm: XX 27-47 YY 54-74
 10mm: XX 16-40 YY 43-68



Parte incasso monocomando doccia INCASSO_ZB005300

MODELLO **ZB005300**

Parte incasso monocomando doccia, doccia incasso 1/2", senza parte esterna



FINITURE DISPONIBILI



04 04 Senza Finitura

CARATTERISTICHE

Installazione	Incasso
Ricambio Cartuccia	ZZ94035000
Cartuccia Monocomando 35 mm	
Incasso	1



Piastra/Plate/Plaque/Platte/Placa
 2-3mm: XX 27-47 YY 54-74
 10mm: XX 16-40 YY 43-68



2026-06-30