

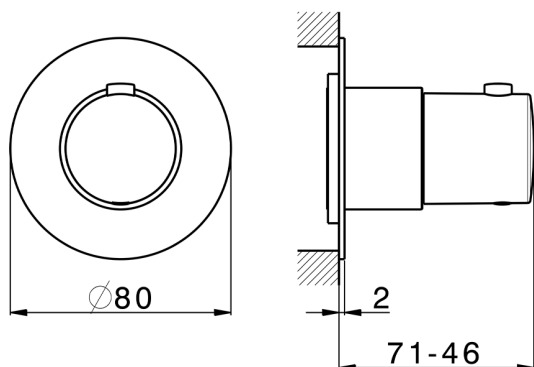

Parte esterna termostatico incasso PUSH&SHOWER_PS0G1010



MODELLO **PS0G1010**

Parte esterna termostatico incasso, senza parte incasso, piastra tonda Ø80 mm, per incasso thermo con scatola di protezione

FINITURE DISPONIBILI

-  **21** 21 Cromo
-  **24** 24 Oro
-  **26** 26 Vecchio Rame
-  **2B** 2B Nichel Lucido
-  **2F** 2F Nichel Spazzolato
-  **2W** 2W Oro Spazzolato
-  **3W** 3W Brushed Black Titanium
-  **5G** 5G Oro Rosa
-  **40** 40 Nero Opaco



Termostatico

Il Termostatico Huber è il tuo personale gestore dell'acqua che ti aiuta a gestire e controllare acqua ed energia senza sprechi.

CARATTERISTICHE

Installazione **Incasso**
Parti Incasso necessarie **ZB0G1000**



Parte esterna termostatico incasso PUSH&SHOWER_PS0G1010

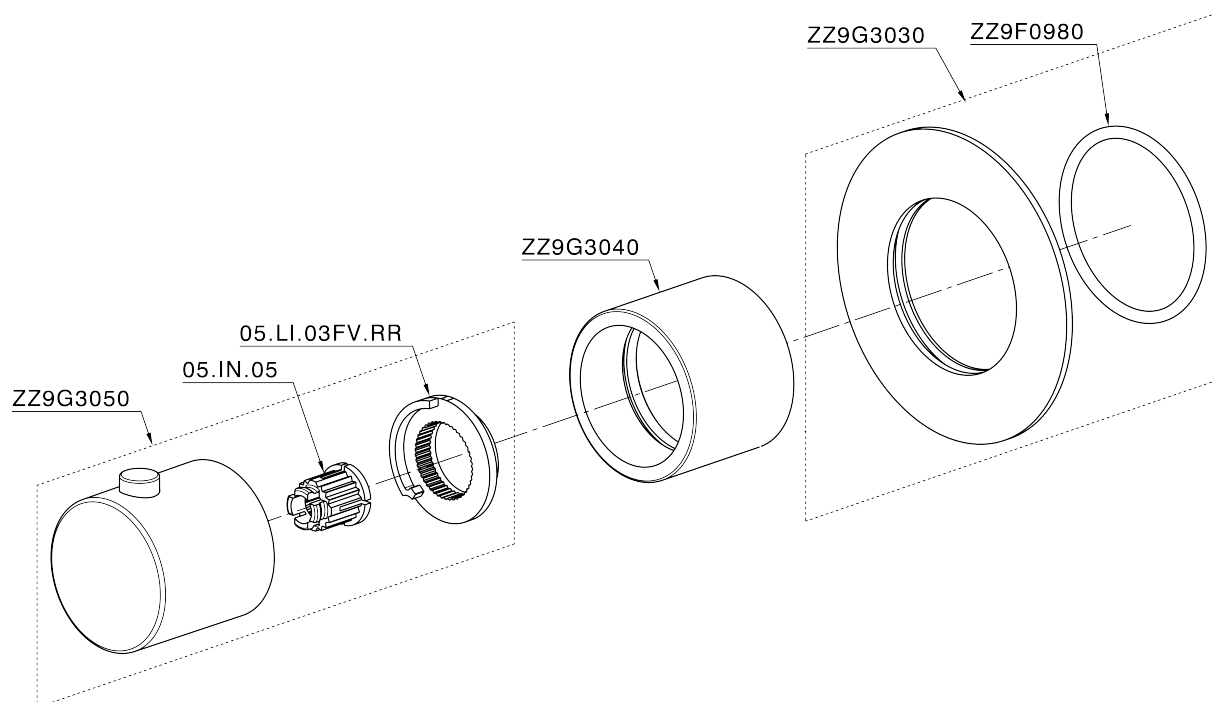

PS0G1010

<https://www.huberitalia.com/parte-esterna-termostatico-incasso-pushshower-ps0g1010>

2026-07-03