

Parte incasso termostatico doccia 1 uscita INCASSO_ZB007300

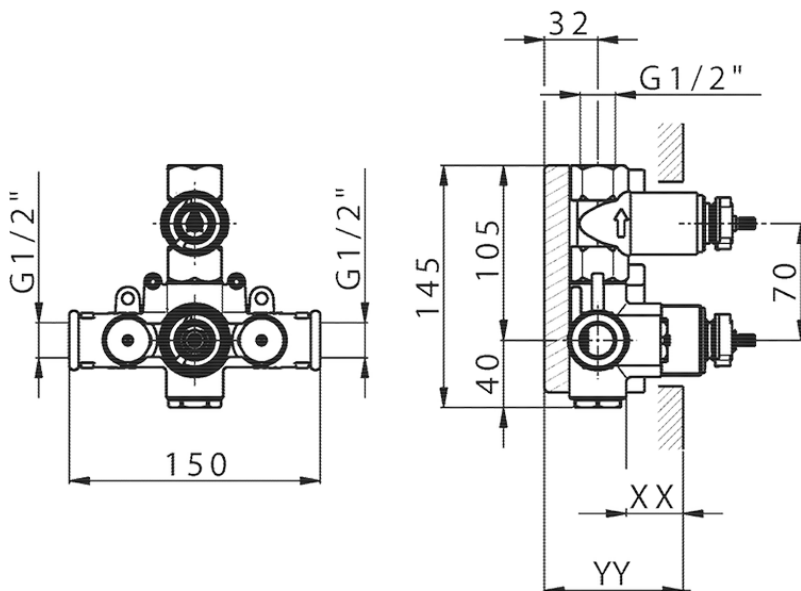

Piastra/Plate/Plaque/Platte/Placa

2-3mm: XX 25-40 YY 76-91

10 mm: XX 16-31 YY 65-80