

## Parte esterna termostatico doccia incasso 1 uscita THERMO\_HC007300



MODELLO **HC007300**

Parte esterna termostatico doccia incasso 1 uscita, con rubinetto d'arresto, senza parte incasso, per art. ZB007300

### FINITURE DISPONIBILI

-  **21** 21 Cromo
-  **2P** 2P Oro Rosa
-  **2Q** 2Q Black Titanium
-  **40** 40 Nero Opaco
-  **4Q** 4Q Bianco Opaco
-  **6T** 6T Cromo/Nero Opaco

### CARATTERISTICHE

Installazione **Incasso**  
 Parti Incasso necessarie **ZB007300**



### Termostatico

Il Termostatico Huber è il tuo personale gestore dell'acqua che ti aiuta a gestire e controllare acqua ed energia senza sprechi.



## Parte incasso termostatico doccia 1 uscita INCASSO\_ZB007300



MODELLO **ZB007300**

Parte incasso termostatico doccia 1 uscita, con rubinetto d'arresto, senza parte esterna

FINITURE DISPONIBILI



**04** 04 Senza Finitura

CARATTERISTICHE

Installazione	<b>Incasso</b>
Ricambio Cartuccia	<b>24.04A.PP</b>
<b>Cartuccia Termostatica Plus P 8X20</b>	
Incasso	<b>1</b>

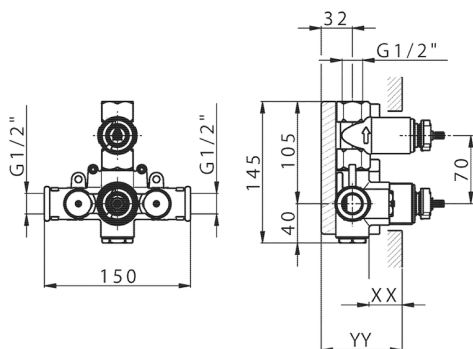

Piastra/Plate/Plaque/Platte/Placa

2-3mm: XX 25-40 YY 76-91

10 mm: XX 16-31 YY 65-80



### Termostatico

Il Termostatico Huber è il tuo personale gestore dell'acqua che ti aiuta a gestire e controllare acqua ed energia senza sprechi.



2026-06-11