



## Parte esterna termostatico vasca incasso 2 uscite CHRONOS\_CR019340

MODELLO **CR019340**

Parte esterna termostatico vasca incasso 2 uscite, con deviasstop 2 uscite, senza parte incasso, per art. ZB019340

### FINITURE DISPONIBILI

-  **21** 21 Cromo
-  **2F** 2F Nichel Spazzolato
-  **2Q** 2Q Black Titanium

### CARATTERISTICHE

Installazione **Incasso**  
Parti Incasso necessarie **ZB019340**

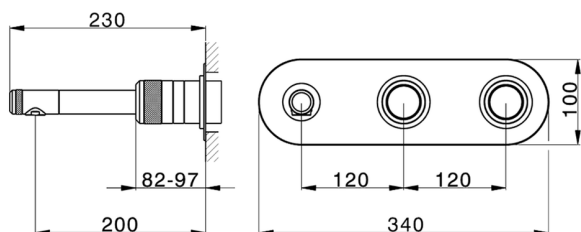

### Termostatico

Il Termostatico Huber è il tuo personale gestore dell'acqua che ti aiuta a gestire e controllare acqua ed energia senza sprechi.



## Parte esterna termostatico vasca incasso 2 uscite CHRONOS\_CR019340

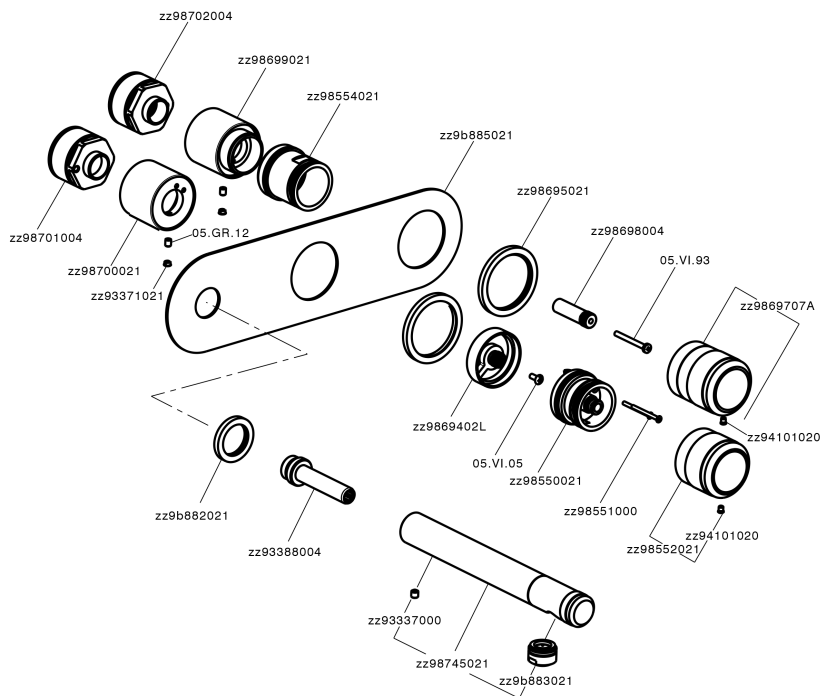

CR019340

<https://www.huberitalia.com/parte-esterna-termostatico-vasca-incasso-2-uscite-chronos-cr019340>

**Parte incasso termostatico vasca 2 uscite INCASSO\_ZB019340**
**MODELLO ZB019340**

Parte incasso termostatico doccia 2 uscite, senza parte esterna

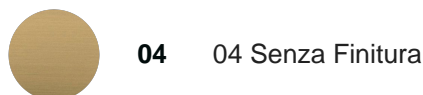
**FINITURE DISPONIBILI**

**CARATTERISTICHE**

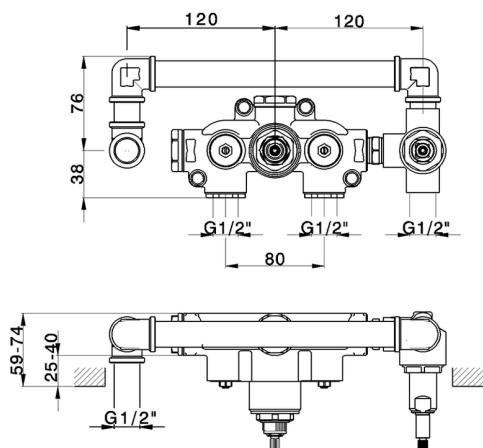
Installazione	<b>Incasso</b>
Ricambio Cartuccia	<b>24.04A.PP</b>
<b>Cartuccia Termostatica Plus P 8X20</b>	
Incasso	<b>1</b>

**Termostatico**

Il Termostatico Huber è il tuo personale gestore dell'acqua che ti aiuta a gestire e controllare acqua ed energia senza sprechi.



2026-06-27