

Pres a d'acqua VICTORIAN_67.04H.

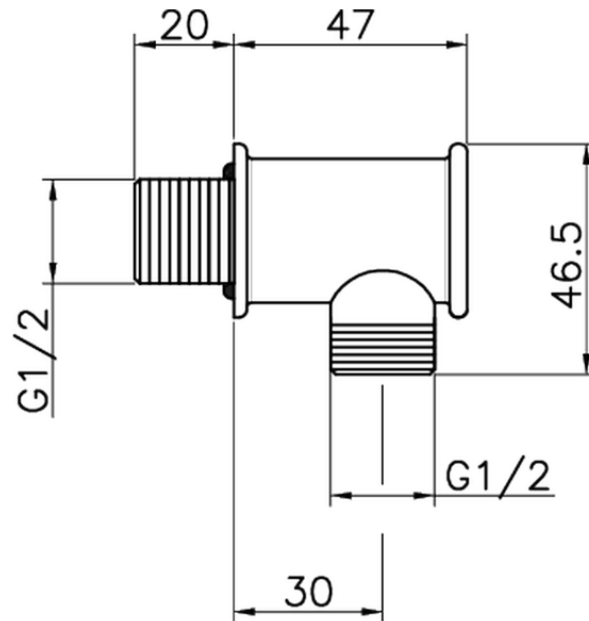

67.04H.

<https://www.huberitalia.com/presa-dacqua-victorian-67-04h>

2026-07-03