

## Bocca di erogazione COMPLEMENTI\_27.01.

MODELLO **27.01.**

Bocca di erogazione

FINITURE DISPONIBILI



CARATTERISTICHE

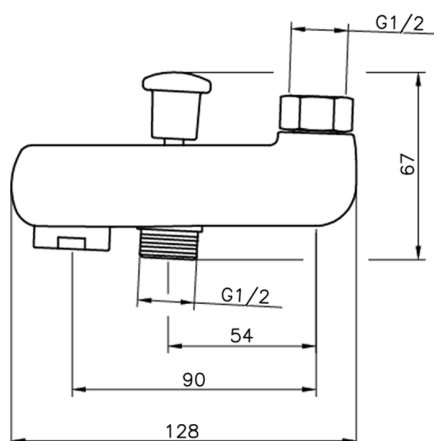

2026-04-17