

## Bocca di erogazione COMPLEMENTI\_27.01.

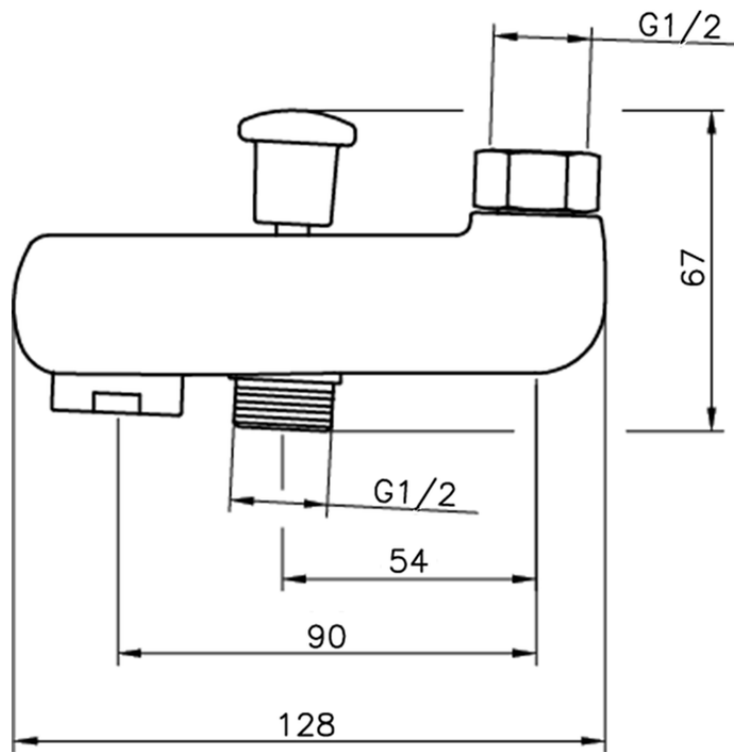

27.01.

<https://www.huberitalia.com/bocca-di-erogazione-complementi-27-01>

2026-04-17