

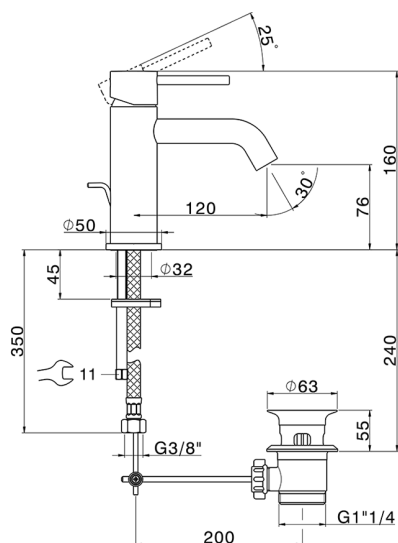





Miscelatore monocomando lavabo NUOVA KIRUNA_K2000510



MODELLO **K2000510**

Miscelatore monocomando lavabo, con scarico automatico 1"1/4, flex inox G.3/8"

FINITURE DISPONIBILI

-  **21** 21 Cromo
-  **26** 26 Vecchio Rame
-  **2F** 2F Nichel Spazzolato
-  **2W** 2W Oro Spazzolato
-  **40** 40 Nero Opaco
-  **4Q** 4Q Bianco Opaco

CARATTERISTICHE

Ricambio Cartuccia **ZZ99672000**

Cartuccia Monocomando 35 mm



EcoStop

Con il Dispositivo EcoStop l'apertura dell'acqua avviene con un punto duro al 50% circa della portata. Un fermo a metà apertura, da vincere con una leggera forza solo e soltanto quando ci sia una reale necessità di richiesta d'acqua alla massima portata. Ciò permette di consumare fino al 50% in meno di acqua.



Miscelatore monocomando lavabo NUOVA KIRUNA_K2000510

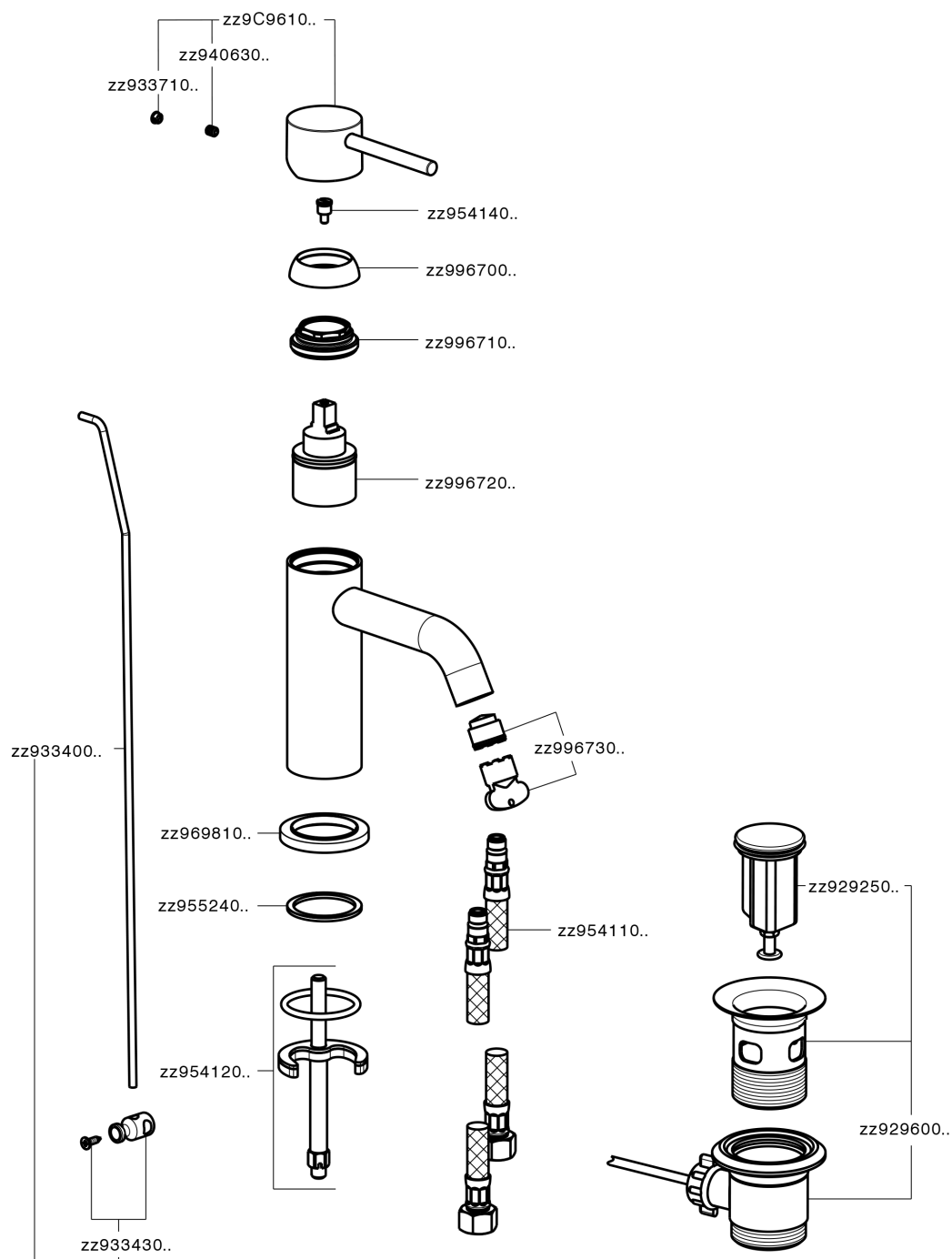

K2000510

<https://www.huberitalia.com/miscelatore-monocomando-lavabo-nuova-kiruna-k2000510>

2026-04-29