

Bocca di erogazione COMPLEMENTI_ZB002620

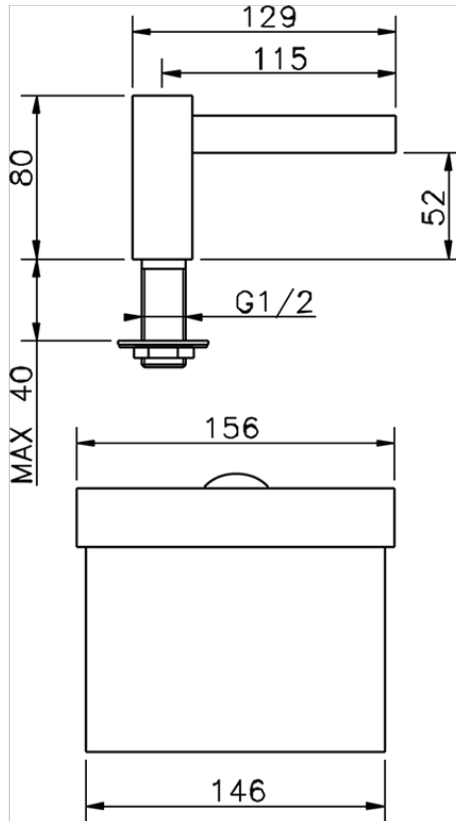

ZB002620

<https://www.huberitalia.com/bocca-di-erogazione-complementi-zb002620>

2026-06-12