

Parte esterna termostatico doccia incasso THERMO_SU007200

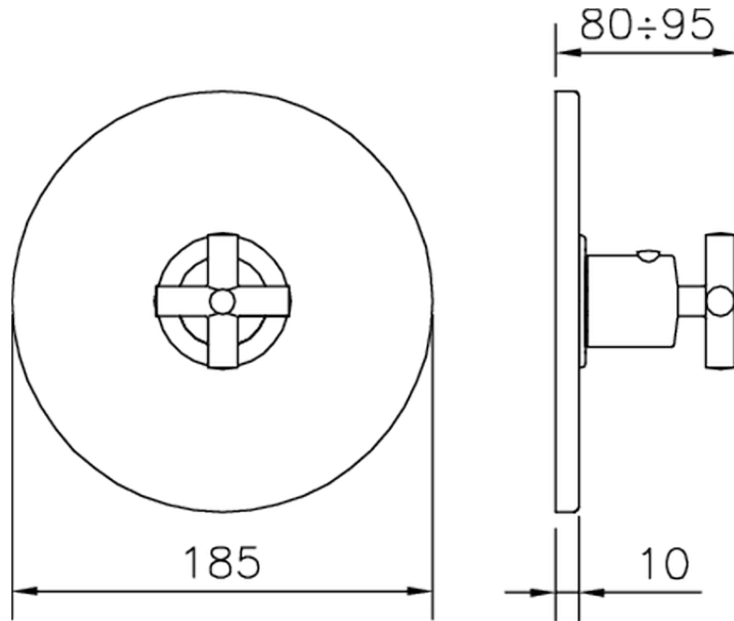

SU007200

<https://www.huberitalia.com/parte-esterna-termostatico-doccia-incasso-thermo-su007200>



Piastra/Plate/Plaque/Platte/Placa

2-3mm: XX 25-40 YY 76-91

10mm: XX 16-31 YY 65-80

ZB007221

<https://www.huberitalia.com/parte-incasso-termostatico-doccia-3-4-incasso-zb007221>

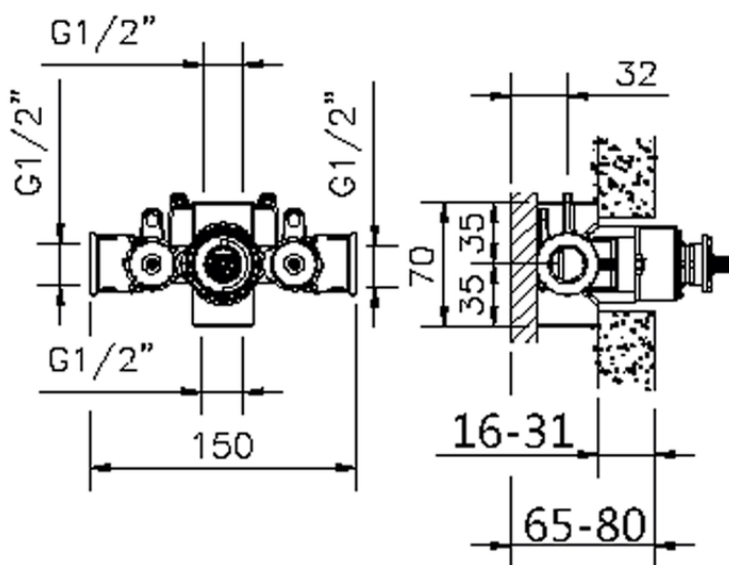

ZB007201

<https://www.huberitalia.com/parte-incasso-termostatico-doccia-1-2-incasso-zb007201>

2026-06-11