

Parte esterna termostatico incasso PUSH&SHOWER_PS0G1030

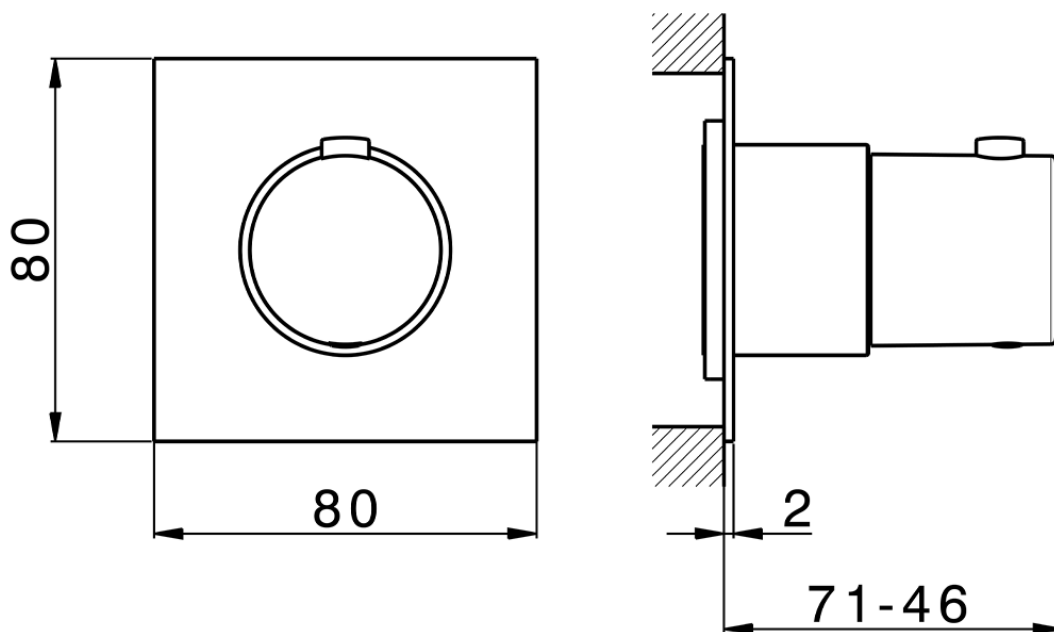

PS0G1030

<https://www.huberitalia.com/parte-esterna-termostatico-incasso-pushshower-ps0g1030>

2026-05-13