







## Parte esterna monocomando vasca a pavimento HARLOCK\_HC014200

MODELLO **HC014200**

Parte esterna monocomando vasca a pavimento, supporto doccetta su colonna, doccetta monogetto minimale D.24mm in Ottone, flessibile liscio SUPREME 150 cm, senza parte incasso (per art.ZB004510)

### FINITURE DISPONIBILI

-  **21** 21 Cromo
-  **2P** 2P Oro Rosa
-  **2Q** 2Q Black Titanium
-  **40** 40 Nero Opaco
-  **4Q** 4Q Bianco Opaco
-  **6T** 6T Cromo/Nero Opaco

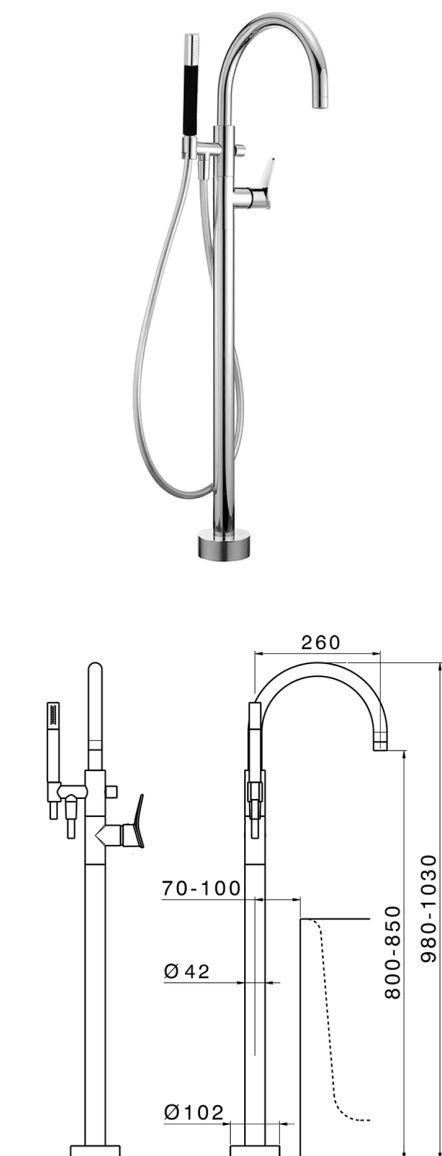

### CARATTERISTICHE

Ricambio Cartuccia **ZZ95409000**

**Cartuccia Monocomando 35 mm**

Installazione **Incasso**

Parti Incasso necessarie **ZB004510**



### EcoStop

Con il Dispositivo EcoStop l'apertura dell'acqua avviene con un punto duro al 50% circa della portata. Un fermo a metà apertura, da vincere con una leggera forza solo e soltanto quando ci sia una reale necessità di richiesta d'acqua alla massima portata. Ciò permette di consumare fino al 50% in meno di acqua.



## Parte incasso monocomando free-standing INCASSO\_ZB004510

MODELLO **ZB004510**

Parte incasso a pavimento, per monocomando free-standing

FINITURE DISPONIBILI

 **04** 04 Senza Finitura



CARATTERISTICHE

Installazione	<b>Incasso</b>
Incasso	<b>1</b>



2026-06-10