

Parte esterna termostatico doccia incasso 2 uscite M32_MT018100

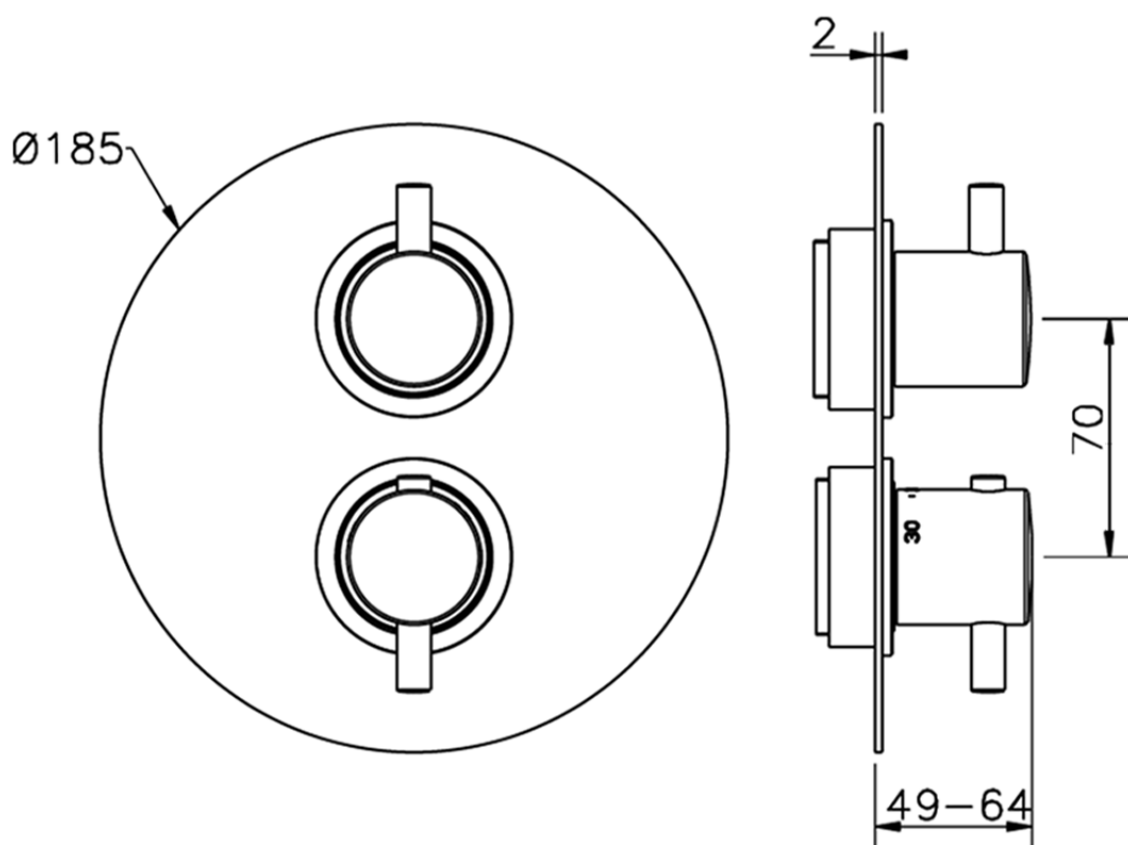

MT018100

<https://www.huberitalia.com/parte-esterna-termostatico-doccia-incasso-2-uscite-m32-mt018100>



Piastra/Plate/Plaque/Platte/Placa

2-3mm: XX 25-40 YY 76-91

10 mm: XX 16-31 YY 65-80

ZB018101

<https://www.huberitalia.com/parte-incasso-termostatico-doccia-2-uscite-incasso-zb018101>

2026-06-28