

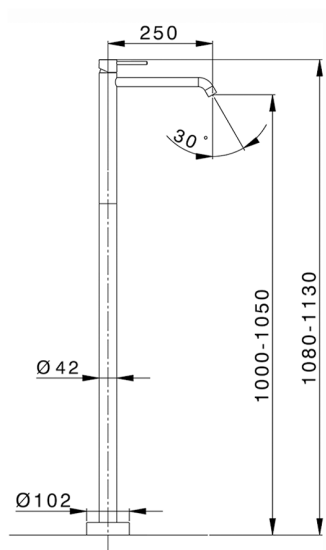





Parte esterna monocomando lavabo a pavimento M32_MT014510



MODELLO **MT014510**

Parte esterna monocomando lavabo a pavimento, senza parte incasso, per art. ZB004510

FINITURE DISPONIBILI

-  **21** 21 Cromo
-  **26** 26 Vecchio Rame
-  **2F** 2F Nichel Spazzolato
-  **2W** 2W Oro Spazzolato
-  **40** 40 Nero Opaco
-  **4Q** 4Q Bianco Opaco

CARATTERISTICHE

Ricambio Cartuccia **ZZ99672000**

Cartuccia Monocomando 35 mm

Installazione **Incasso**

Parti Incasso necessarie **ZB004510**



EcoStop

Con il Dispositivo EcoStop l'apertura dell'acqua avviene con un punto duro al 50% circa della portata. Un fermo a metà apertura, da vincere con una leggera forza solo e soltanto quando ci sia una reale necessità di richiesta d'acqua alla massima portata. Ciò permette di consumare fino al 50% in meno di acqua.



Parte esterna monocomando lavabo a pavimento M32_MT014510



MT014510

<https://www.huberitalia.com/parte-esterna-monocomando-lavabo-a-pavimento-m32-mt014510>

Parte incasso monocomando free-standing INCASSO_ZB004510

MODELLO **ZB004510**

Parte incasso a pavimento, per monocomando free-standing

FINITURE DISPONIBILI

 **04** 04 Senza Finitura



CARATTERISTICHE

Installazione	Incasso
Incasso	1



2026-05-15