

Parte incasso termostatico 2 funzioni INCASSO_ZB01R200

MODELLO **ZB01R200**

Parte incasso termostatico 2 funzioni

FINITURE DISPONIBILI

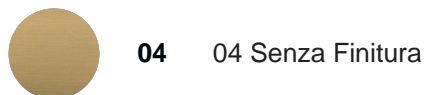

CARATTERISTICHE

Installazione	Incasso
Ricambio Cartuccia	23.51A.HF
Cartuccia Termostatica HF	
Incasso	1

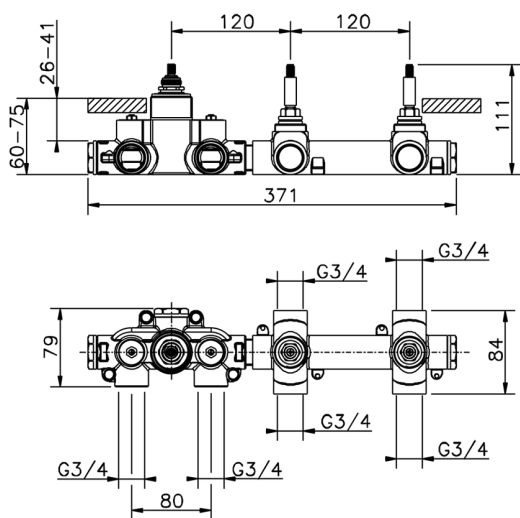

Termostatico

Il Termostatico Huber è il tuo personale gestore dell'acqua che ti aiuta a gestire e controllare acqua ed energia senza sprechi.



2026-06-16