

Bocca di erogazione COMPLEMENTI_ZB002200

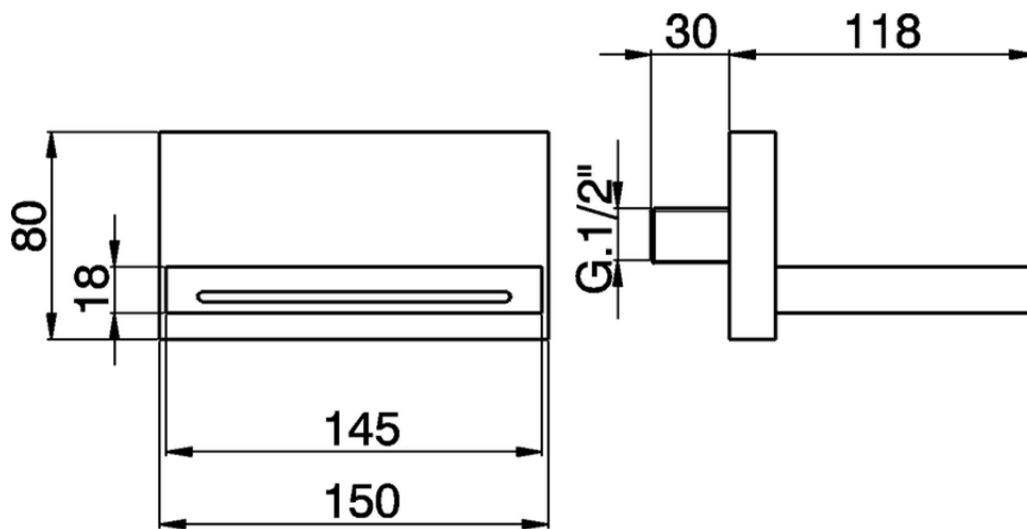

ZB002200

<https://www.huberitalia.com/bocca-di-erogazione-complementi-zb002200>

2026-06-12