





Parte esterna termostatico doccia incasso 1 uscita THERMO_SU007304



MODELLO **SU007304**

Parte esterna termostatico doccia incasso 1 uscita, rubinetto d'arresto, senza parte incasso, per art. ZB007301-ZB007361

FINITURE DISPONIBILI

-  **21** 21 Cromo
-  **40** 40 Nero Opaco
-  **2F** 2F Nichel Spazzolato
-  **2W** 2W Oro Spazzolato

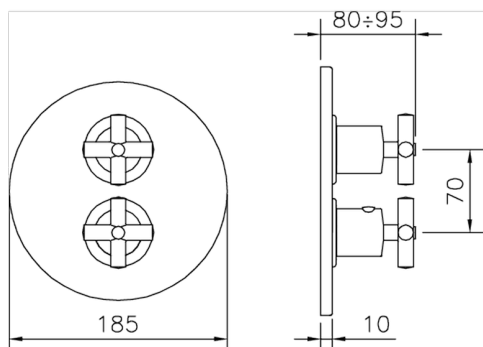

CARATTERISTICHE

Installazione **Incasso**
 Parti Incasso necessarie **ZB007361**
ZB007301



Termostatico

Il Termostatico Huber è il tuo personale gestore dell'acqua che ti aiuta a gestire e controllare acqua ed energia senza sprechi.



Parte incasso termostatico doccia 1 uscita INCASSO_ZB007361

MODELLO **ZB007361**

Parte incasso termostatico doccia 1 uscita, rubinetto d'arresto con uscita 3/4", senza parte esterna

FINITURE DISPONIBILI



04 04 Senza Finitura



CARATTERISTICHE

Installazione	Incasso
Ricambio Cartuccia	23.51A.HF
Cartuccia Termostatica HF	
Incasso	1

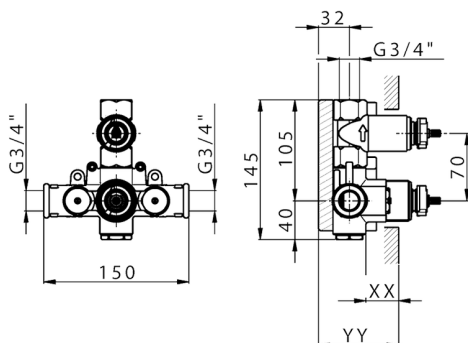

Piastra/Plate/Plaque/Platte/Placa
 2-3mm: XX 25-40 YY 76-91
 10 mm: XX 16-31 YY 65-80



Termostatico

Il Termostatico Huber è il tuo personale gestore dell'acqua che ti aiuta a gestire e controllare acqua ed energia senza sprechi.



Parte incasso termostatico doccia 1 uscita INCASSO_ZB007301

MODELLO **ZB007301**

Parte incasso termostatico doccia 1 uscita, con rubinetto d'arresto, senza parte esterna

FINITURE DISPONIBILI



04 04 Senza Finitura



CARATTERISTICHE

Installazione	Incasso
Ricambio Cartuccia	24.04A.PP
Cartuccia Termostatica Plus P 8X20	
Incasso	1



Piastra/Plate/Plaque/Platte/Placa

2-3mm: XX 25-40 YY 76-91

10 mm: XX 16-31 YY 65-80



Termostatico

Il Termostatico Huber è il tuo personale gestore dell'acqua che ti aiuta a gestire e controllare acqua ed energia senza sprechi.



2026-04-17