

Parte esterna monocomando doccia incasso H2_H2003000

MODELLO **H2003000**

Parte esterna monocomando doccia incasso, senza parte incasso, per art. ZB005300

FINITURE DISPONIBILI



CARATTERISTICHE

Installazione **Incasso**

Parti Incasso necessarie **ZB005300**

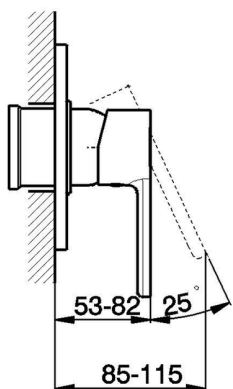
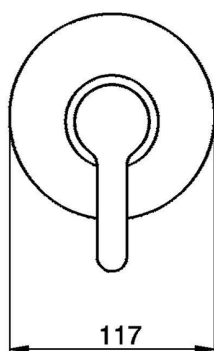

Parte esterna monocomando doccia incasso H2_H2003000

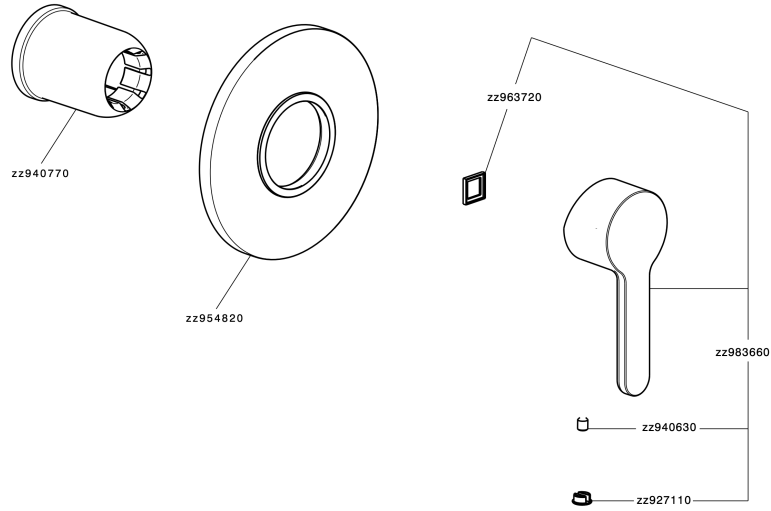

H2003000

<https://www.huberitalia.com/parte-esterna-monocomando-doccia-incasso-h2-h2003000>

Parte incasso monocomando doccia INCASSO_ZB005300

MODELLO **ZB005300**

Parte incasso monocomando doccia, doccia incasso 1/2", senza parte esterna



FINITURE DISPONIBILI



04 04 Senza Finitura

CARATTERISTICHE

Installazione	Incasso
Ricambio Cartuccia	ZZ94035000
Cartuccia Monocomando 35 mm	
Incasso	1



Piastra/Plate/Plaque/Platte/Placa
 2-3mm: XX 27-47 YY 54-74
 10mm: XX 16-40 YY 43-68



2026-06-29