

Deviatore incasso 2 uscite LYNOX_LX000200

MODELLO **LX000200**

Deviatore incasso 2 uscite, uscite 1/2" F, Inox AISI 316L

FINITURE DISPONIBILI



D1 D1 Inox Spazzolato

CARATTERISTICHE

Installazione

Incasso

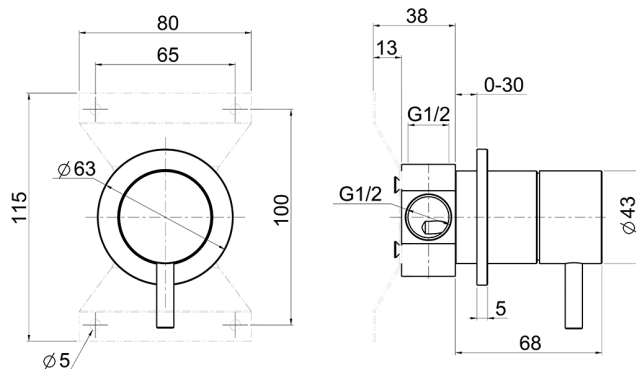

DeviaStop

La tecnologia Devia Stop di Huber consente con un semplice movimento rotativo di gestire la portata dell'acqua e di scegliere la modalità d'erogazione (soffione, doccetta a mano).



2026-04-14